

ORDER SHEET

Client/Project Name: _____

Please fill in the below information specification i.e. power/data options etc.
Only fully detailed sheets, signed and dated will be accepted by PLN.

This sheet is to be printed, scanned and attached to the relevant PO for PLN.

ROAM

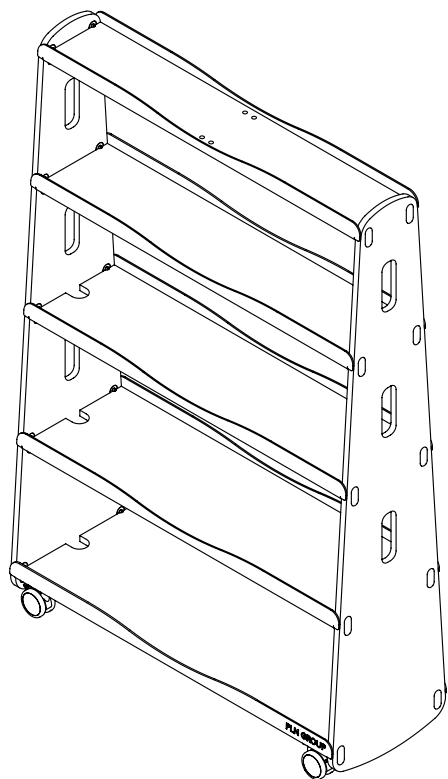

QUANTITY

Specify the quantity of Roam Base Units: _____

COLOUR (PLEASE TICK COLOUR REQUIRED)

Standard Colour



WHITE



BLACK



WASABI



STONE GREY



DENIM



SAFFRON

NAME: _____ SIGNATURE: _____ DATE: _____

ORDER SHEET





Client/Project Name: _____





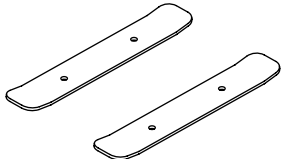
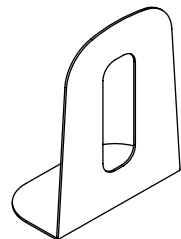

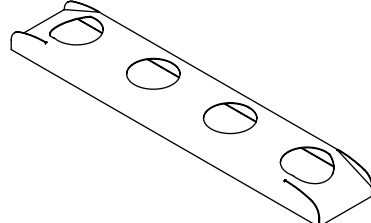
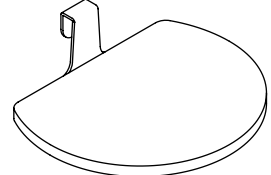
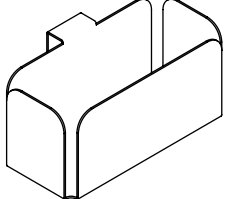
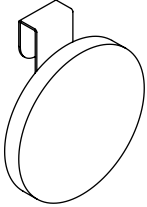
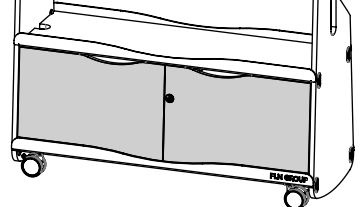
Please fill in the below information specification i.e. power/data options etc.
Only fully detailed sheets, signed and dated will be accepted by PLN.

This sheet is to be printed, scanned and attached to the relevant PO for PLN.

ROAM ACCESSORIES (PLEASE ENTER QUANTITY NEEDED IN BOX PROVIDED)

<p>BOARD HOOKS</p> <p><input type="checkbox"/></p> 	<p>BOOK HOLDER</p> <p><input type="checkbox"/></p> 	<p>TV ATTACHMENT</p> <p><input type="checkbox"/></p> 	<p>TOP SHELF PLANTER</p> <p><input type="checkbox"/></p> 
<p>LAPTOP TABLE</p> <p><input type="checkbox"/></p> 	<p>HANGER BOX</p> <p><input type="checkbox"/></p> 	<p>CABLE REEL</p> <p><input type="checkbox"/></p> 	<p>SECURE LOCKER</p> <p><input type="checkbox"/></p> 

COLOUR (PLEASE TICK COLOUR REQUIRED)

<input type="checkbox"/>		WHITE
<input type="checkbox"/>		STONE GREY
<input type="checkbox"/>		BLACK
<input type="checkbox"/>		DENIM
<input type="checkbox"/>		WASABI
<input type="checkbox"/>		SAFFRON

NAME: _____ SIGNATURE: _____ DATE: _____

ORDER SHEET



Client/Project Name: _____

Please fill in the below information specification i.e. power/data options etc.
Only fully detailed sheets, signed and dated will be accepted by PLN.

This sheet is to be printed, scanned and attached to the relevant PO for PLN.

ROAM ACCESSORIES

PINBOARD

QUANTITY

Specify the quantity of Pinboard units: _____

(PLEASE TICK BOX OF COLOUR NEEDED)

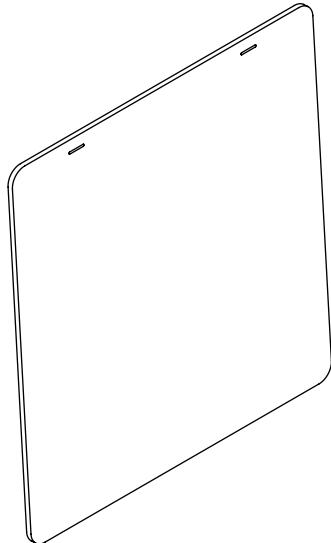

<input type="checkbox"/>		ACROS	<input type="checkbox"/>		OPERA
<input type="checkbox"/>		BOSCO	<input type="checkbox"/>		PETRONAS
<input type="checkbox"/>		EMPIRE	<input type="checkbox"/>		PINNACLE
<input type="checkbox"/>		FALLING WATER	<input type="checkbox"/>		ROSADA
<input type="checkbox"/>		FLATIRON	<input type="checkbox"/>		SAVOYE
<input type="checkbox"/>		GALAXY	<input type="checkbox"/>		SENADO
<input type="checkbox"/>		IRONBANK	<input type="checkbox"/>		TREE HOUSE
<input type="checkbox"/>		LOTUS	<input type="checkbox"/>		ZENITH

WHITEBOARD

QUANTITY

Specify the quantity of Whiteboard units: _____

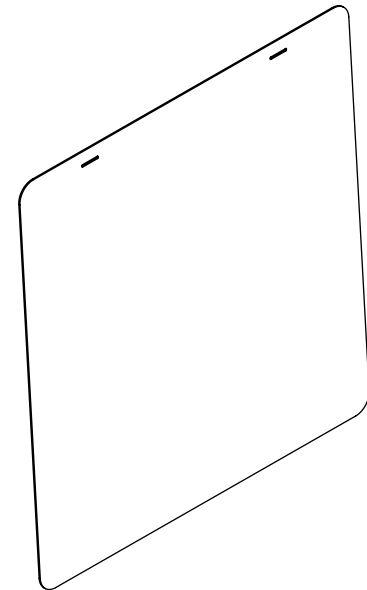

NAME: _____ SIGNATURE: _____ DATE: _____